

**ATCS-50**

( URL )

Audio-Technica Greater China Limited )

(

**ATCS-50**

ATCS-M55  
ATCS-M55



1.2

1.1

\*

\*

\*

\*

-

-

-

-

-

-

-

-

-

) ( ) ( ) ( )

) 4 ( ) 3 (

6 [ ] [ ] [ ] [ ]

( )

-

- ( ) LED

- ( ) LED

- ( )

- ( )

- ( )

- ( ) ( )

-

-2

2

-

- ( )

- / / ( )

- ( )

2.1

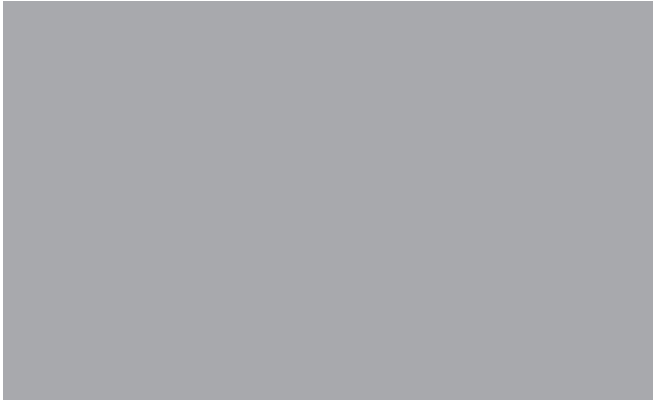

- 
- 
- 
-

## 2.2

### 2.2.1

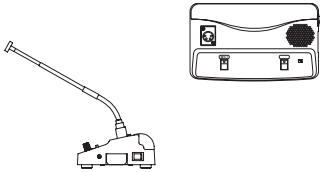

- -
  - -
  - -
  - -
  - -
  
  - [ /1] - [ ] 1
  - [ /2] - [ ] 2
  - [ /3] - [ ] 3
  - [ /4] - 4
  - [ /5] - 5
  
  - -
  - - 1 2
  
  - -
  - - ID
-



2.2.2

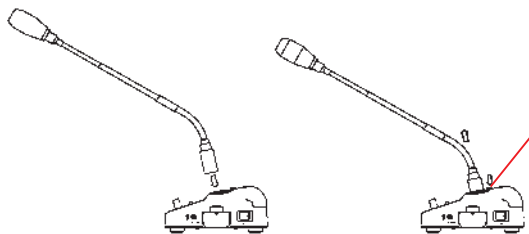

- 
- 
- 
- \*

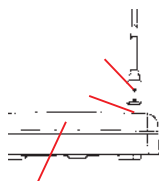

- 
- 

2.2.3

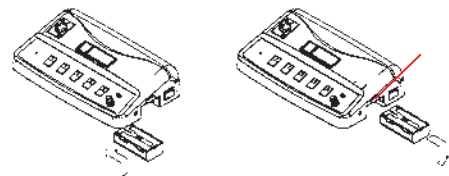

- 
- 
- 
- 
- 

( )

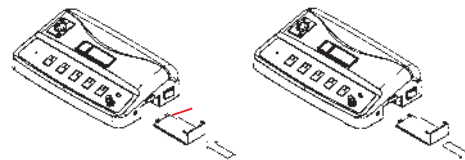

- 
- 
- \*
- \*
- 
-



## 2.4

### 2.4.1

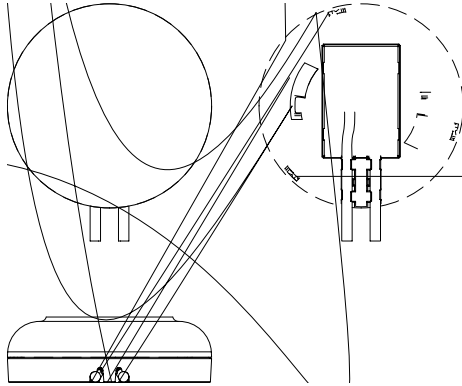

- -            (    )
- -            (    )
- -            (    )
- -
- -

## 2.5

### 2.5.1



- -

- -  
- -  
\* -

- 1A
- 220V
- Ø5.2 x 20mm

3.1

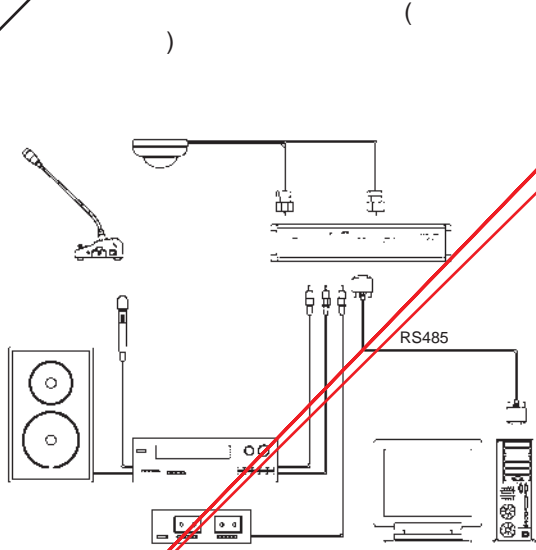

(Rx, Tx)

F

3.2

ID



- 1.

ID

- 2.

ID

1

0

(0-9)

(0-9)

[035]

- 3.

ID

- 4.

ID

### 3.3

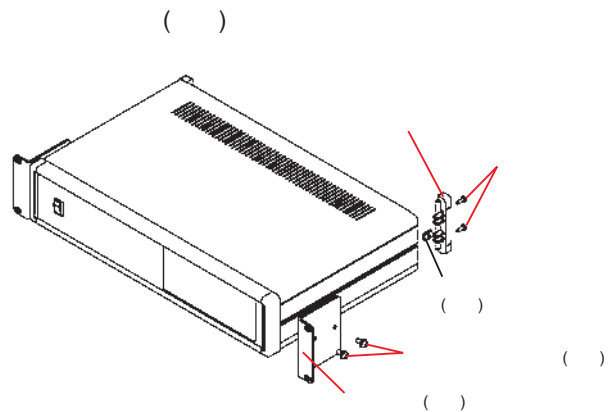

- 1.

- 2.

- 3. ( 2 )

- 4.

- 5. ( 2 )

- 6.

\*

### 3.4

#### 3.4.1

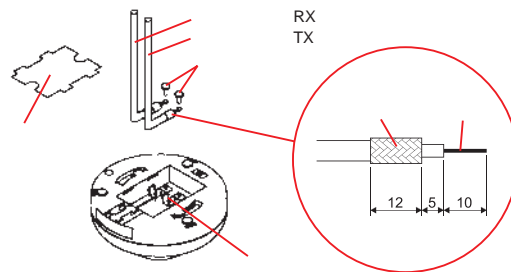

- 1.

- 2.

- 3.

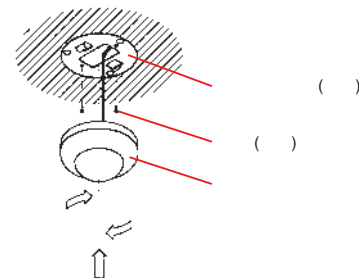

- 4.

- 5.

3.4.2

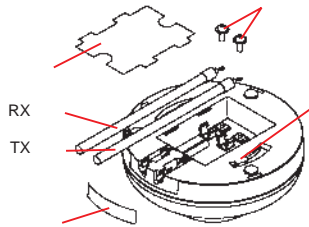

- 1.
- 2.
- 3.
- 4.
- 5.
- 6.

\*

TX  
RX

TX  
RX

\*

\*

3.4.3

( )

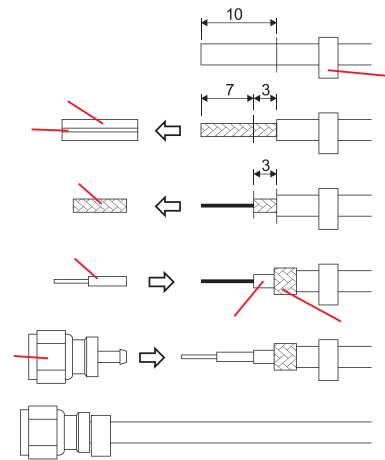

- 1.
- 2.
- 3.
- 4.
- 5.

\*

3.5

h=2.0m	d=11.5m
h=2.5m	d=11.0m
h=3.0m	d=10.2m

3.5.1

-

-

-

-

-

3.5.3

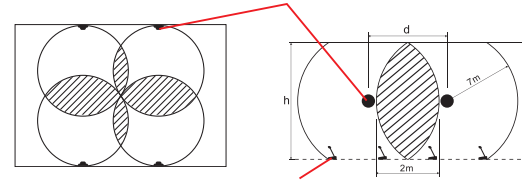

3.5.2

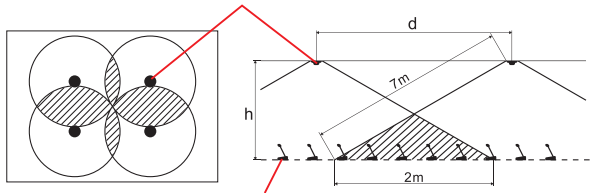

h=

d=

\*

7m

150°

\*

2m

\*

12m

h=

d=

\*

7m

150°

\*

2m



4.1

4.1.1

- ID 001



[ /4] [ /5]

- [ /4]

- ( )

- [ /5]

4.1.2

- ID 002 150  
149



[ /4] [ /5]

- [ /4]

- ( )

- 3 4

- 6

-

-

-

-

- [ /5]

4.1.3

-

[ /5]



[ /5]

4.1.4

- 主



[ /5]  
[ /4]

-

[ /4] [ /5]

( )

4.1.5 (ATCS-M55 )

- ID 001
- ID 002 150  
149



- [TALK]

-

-

3

4

-

6

-

-

-

- [TALK]

4.1.6 (ATCS-M55 )

- [TALK]



5.2

5.1 (ATCS-M55 )

5.1.1

- \*
- \*
- 5

5.1.2

- 1.
- 2.
- 3.



- 1. [ /4] (ATCS-M55 TALK )
- 2.
- 3.



[ /4]

\*

6.1

- a.
- b. 1~3 MHz
- c. FM
- d. 4 / 2 / 1
- e. 2400 bps
- f. 7.4V 1600mAh  
12V 500mA ( )
- g. 240 x 648 x 145mm (ATCS-M50)  
120 x 130 x 110mm (ATCS-M55)
- h. 1 (ATCS-M50)  
550 (ATCS-M55)
- i. (ATCS-M50)、

6.2

- a.
- b. 1~3 MHz
- c. FM
- d. 4 / 2 / 1
- e. 2400 bps
- f. (-10dBV) 2

- g. (-10dBV) 2
- h. (-10dBV) 2
- i. 220V 50/60Hz
- j. 430 x 88 x 280mm
- k. 5.6
- l. ID

6.3

- a. 1~3 MHz
- b. 4 / 2 / 1
- c. 12V
- d. Ø108 x 56.4mm
- e. 145
- f. 、

6.4

- a. 220V 50/60Hz
- b. 7.4V (UR-121)
- c. 4
- d. 10
- e. -  
-
- f. -

- g. 0 ~ 40°C
- h. 130 x 94 x 361.2mm
- i. 4.3

## 6.5

- UR-121
- ATCS-49Q
- ATCS-935/ML
- AD1210JW
- DME-3
- 10 ATCS-M50CSE



