

ATCS-50

(URL)

Audio-Technica Greater China Limited)

(

ATCS-50

ATCS-M55
ATCS-M55

1.2

1.1

*

*

*

*

-

-

-

-

-

-

-

-

-

) () (

()

) 4 () 3 (

()

6 [] [] [] []

()

-

- () LED

- () LED

- ()

- ()

- () ()

-

-2

2

-

- ()

- / / ()

- ()

2.1

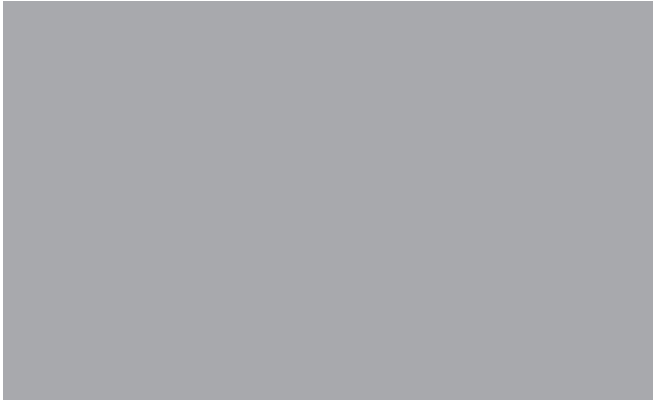

-
-
-
-

2.2

2.2.1

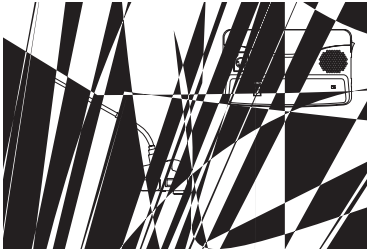

- -
- -
- -
- -
- -
- [/1] - [] 1
- [/2] - [] 2
- [/3] - [] 3
- [/4] - 4
- [/5] - 5
- -
- - 1 2
- -
- - ID

2.2.2

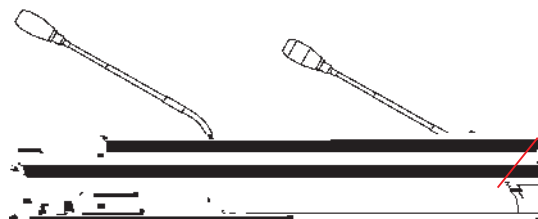

-
-
-
- *

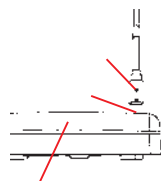

-
-

2.2.3

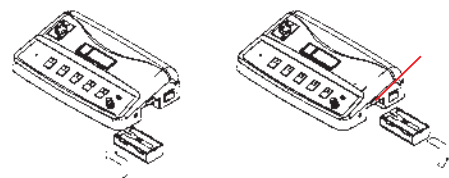

-
-
-
-
-

()

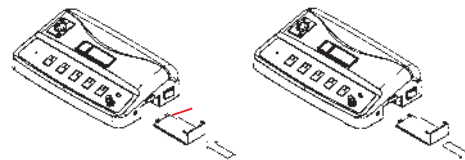

-
-
- *
- *
-
-

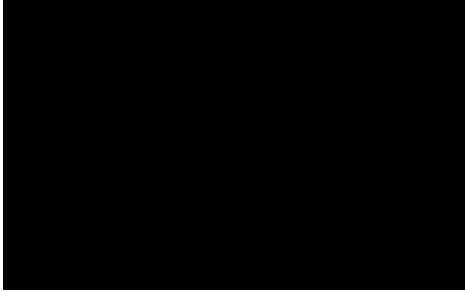

2.4

2.4.1

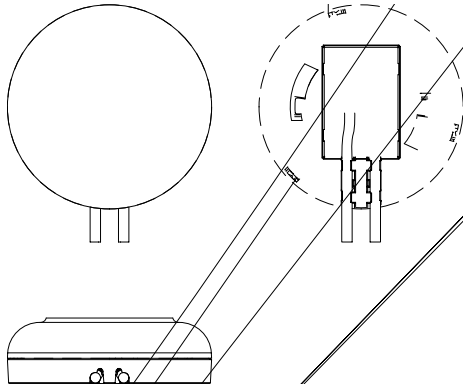

- - ()
- - ()
- - ()
- -
- -

2.5

2.5.1



- -

- -
- -
* -

- 1A
- 220V
- Ø5.2 x 20mm

3.

3.2

ID



(Rx, Tx)

- 1.

- 2.

- 3.

- 4.

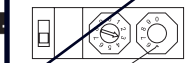

ID

ID

1

0

(0-9)

(0-9)

035

ID

ID

3.3

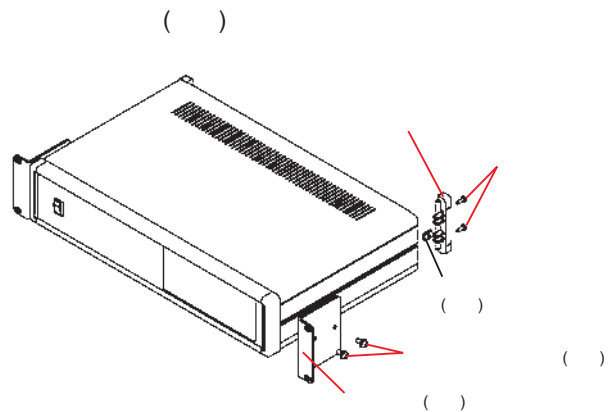

- 1.

- 2.

- 3. (2)

- 4.

- 5. (2)

- 6.

*

3.4

3.4.1

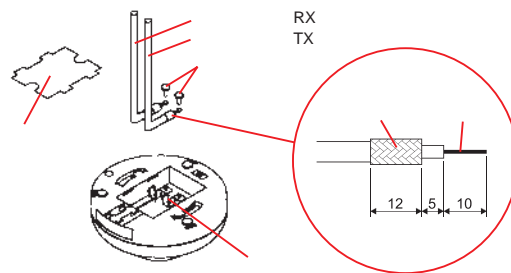

- 1.

- 2.

- 3.

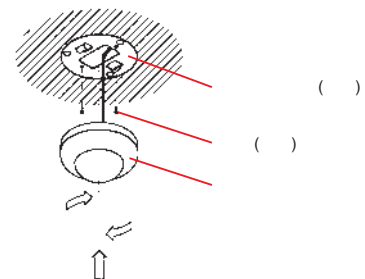

- 4.

- 5.

3.4.2

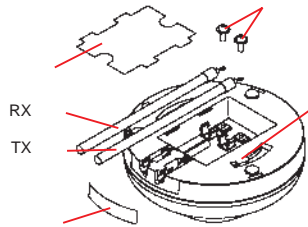

- 1.
- 2.
- 3.
- 4.
- 5.
- 6.

*

TX
RX

TX
RX

*

*

3.4.3

()

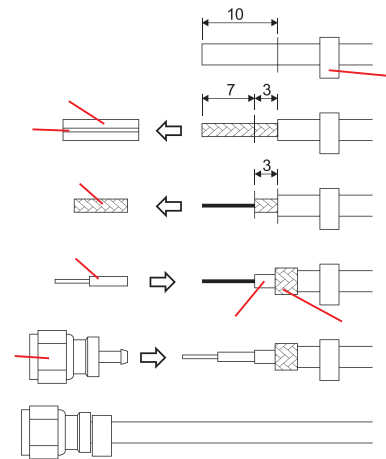

- 1.
- 2.
- 3.
- 4.
- 5.

*

3.5

h=2.0m	d=11.5m
h=2.5m	d=11.0m
h=3.0m	d=10.2m

3.5.1

-

-

-

-

-

3.5.3

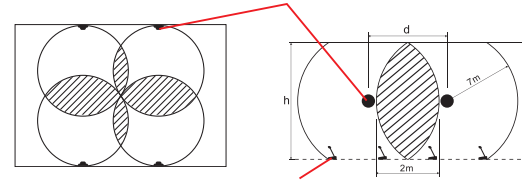

3.5.2

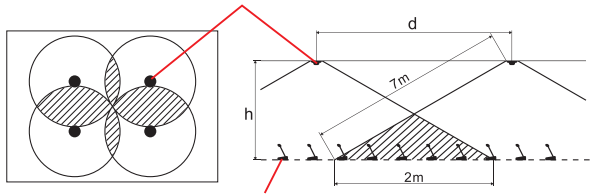

h=

d=

*	7m	150°
*	2m	
*		12m

h=

d=

*	7m	150°
*	2m	

4.1

4.1.1

- ID 001



[/4] [/5]

- [/4]

- ()

- [/5]

4.1.2

- ID 002 150
149



[/4] [/5]

- [/4]

- ()

- 3 4

- 6

-

-

-

- [/5]

4.1.3

-

[/5]



[/5]

4.1.4

- 主



[/5]
[/4]

-

[/4] [/5]

()

4.1.5 (ATCS-M55)

- ID 001
- ID 002 150
149



- [TALK]

-

-

3

4

-

6

-

-

-

- [TALK]

4.1.6 (ATCS-M55)

- [TALK]



5.2

5.1 (ATCS-M55)

5.1.1

- *
- * 5

5.1.2

- 1.
- 2.
- 3.



- 1. [/4] (ATCS-M55 TALK)
- 2.
- 3.



[/4]

*

6.1

- a.
- b. 1~3 MHz
- c. FM
- d. 4 / 2 / 1
- e. 2400 bps
- f. 7.4V 1600mAh
12V 500mA ()
- g. 240 x 648 x 145mm (ATCS-M50)
120 x 130 x 110mm (ATCS-M55)
- h. 1 (ATCS-M50)
550 (ATCS-M55)
- i. (ATCS-M50)、

6.2

- a.
- b. 1~3 MHz
- c. FM
- d. 4 / 2 / 1
- e. 2400 bps
- f. (-10dBV) 2

- g. (-10dBV) 2
- h. (-10dBV) 2
- i. 220V 50/60Hz
- j. 430 x 88 x 280mm
- k. 5.6
- l. ID

6.3

- a. 1~3 MHz
- b. 4 / 2 / 1
- c. 12V
- d. Ø108 x 56.4mm
- e. 145
- f. 、

6.4

- a. 220V 50/60Hz
- b. 7.4V (UR-121)
- c. 4
- d. 10
- e. -
-
- f. -

- g. 0 ~ 40°C
- h. 130 x 94 x 361.2mm
- i. 4.3

6.5

- UR-121
- ATCS-49Q
- ATCS-935/ML
- AD1210JW
- DME-3
- 10 ATCS-M50CSE

7.2

ID

ID	
191	- -[A] -
192	- -[B]
193	- -[C]
194	- -[D]

7.1

	-	-
	-	-
	-	-
	-	-
	-	-
	-	-
	-	-
	- ID [150]	- ID [001] [150]
	-	-
	-	-
	-	-
	-	-
	- 7 ()	- TX RX
	-	-
	-	-
4	-	-
	-	-
	-	-
	-	-
	-	-

1.

2. ID [191]
[/1]
[A]

3. ID [192]、
[193]、[194] [/1]

